

Z.I des Ajeux - 72400 La Ferté-Bernard - France  
Tél. : +33 (0)2 43 60 40 00 / Fax : +33 (0)2 43 60 40 09

 www.securlite.com

## Produit, caractéristiques techniques et fonctionnalités

### RONDO :

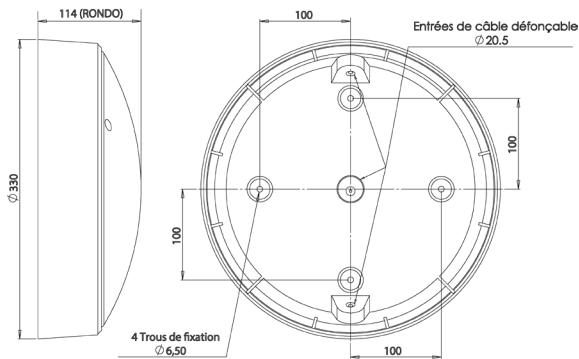

### Kit d'installation standard :

Passerelle x1  
Rondelle Caoutchouc x4  
Rondelle Métallique x4

### Caractéristiques générales :

Tension nominale : 220 - 240V AC – 50 / 60 Hz  
Plage de tension d'entrée : 198V – 264V AC  
Classe de protection : I  
Indice de protection : IP66 (RONDO / RONDINO) / IP65 (Avec grille)  
Indice de résistance aux chocs mécaniques :  
IK11++ / 120j (RONDO / RONDINO)  
IK11+ / 80j (Version grille)

### Source lumineuse : LED

Ce produit contient une source lumineuse de classe d'efficacité énergétique C.

**Puissance(s) :** Se reporter à l'étiquette produit.

**Référence(s) :** Se reporter à l'étiquette produit.

- Réf. Générique : 25xxxx00 sans détection (se reporter à cette notice).
- Réf. avec terminaison optionnelle (se reporter à la notice complémentaire).

### Autre(s) référence(s) avec option(s) :

- Se reporter aux notices complémentaires.

### RONDINO :

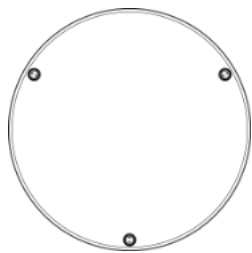
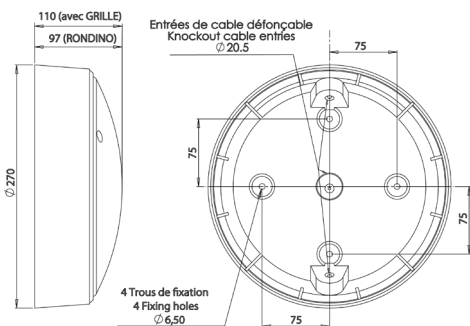

RONDO

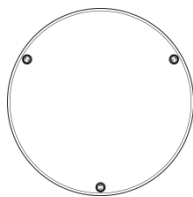

RONDINO<sup>2</sup>

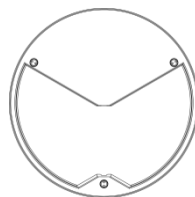

AKI

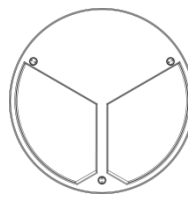

AKITA

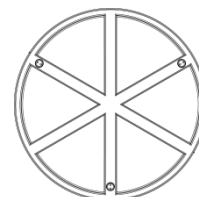

RUEDA

## Conditions d'utilisation

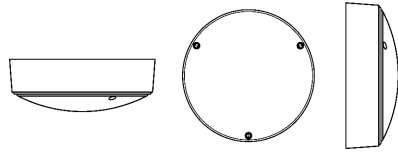
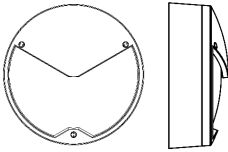
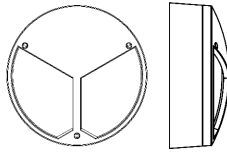
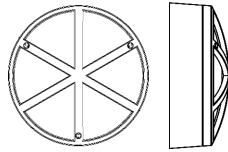
 <p>RONDO / RONDINO</p>	 <p>AKI</p>	 <p>AKITA</p>	 <p>RUEDA</p>
OK	OK	OK	OK

## Montage / Installation



Attention, risque de chocs ESD sur les LEDs.



Le montage et l'installation doit être fait par un installateur professionnel en respectant les normes d'installation en vigueur.



Couper l'alimentation avant la pose et le branchement.

### Ouverture luminaire :

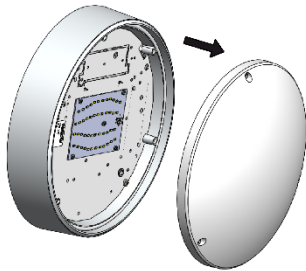

Déposer l'ensemble diffuseur  
ou diffuseur + grille

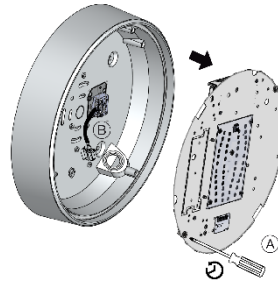

A - Dévisser la platine  
B - Déconnecter la platine

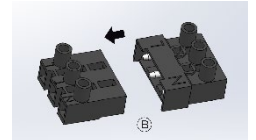

### Préparation passage et entrée de câble :

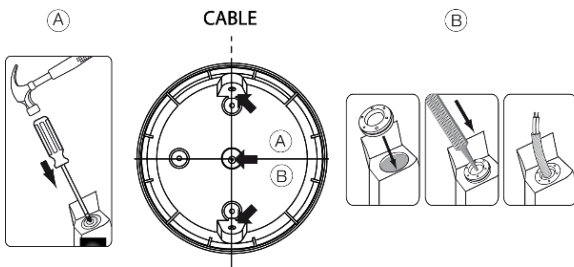

Afin de garantir l'étanchéité du luminaire l'utilisation des passe-fils est impérative.

Utiliser un câble de type U1000R2V 1.5mm<sup>2</sup> (préconisé pour le respect de l'étanchéité).

Percer un passe fils en son centre à l'aide d'une pointe. Ne pas utiliser de lame qui pourrait fragiliser le passe fils et nuire à l'étanchéité.

Monter le passe fils dans l'entrée de câble et introduire le câble d'alimentation au travers de celui-ci.

### Fixation :

Version applique :

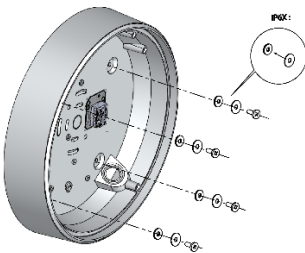

Version encastrée :

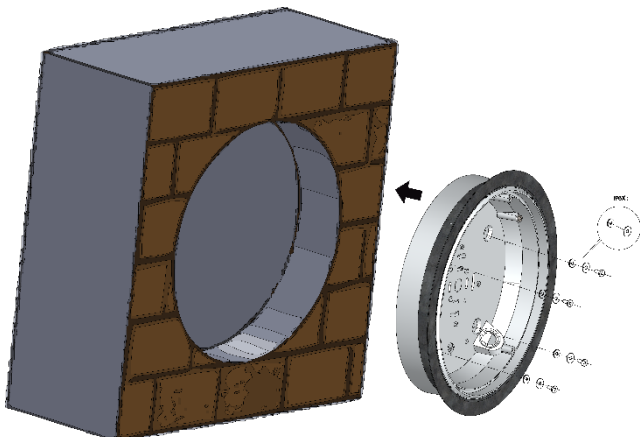

Attention, risque de chocs ESD sur les LEDs.

Z.I des Ajeux - 72400 La Ferté-Bernard - France  
Tél. : +33 (0)2 43 60 40 00 / Fax : +33 (0)2 43 60 40 09

 [www.securlite.com](http://www.securlite.com)

## Montage / Installation (suite)

### Raccordement électrique (Réf. générique 25xxx00):

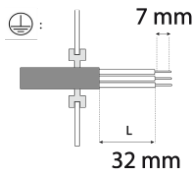

Le câble devra être dénudé selon schémas.  
Les fils devront être dénudés sur une longueur de 7mm.  
Respecter la polarité.

➤ Pour autres cas, se reporter aux notices particulières pour raccordement et repiquage.

### Fermeture du luminaire :

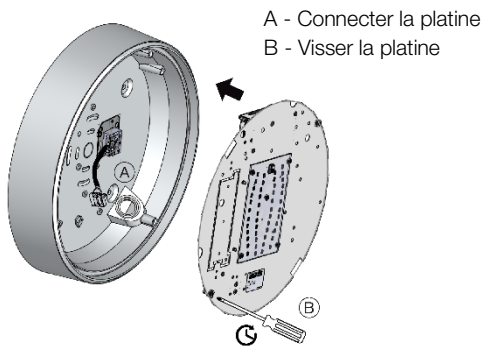

A - Connecter la platine  
B - Visser la platine

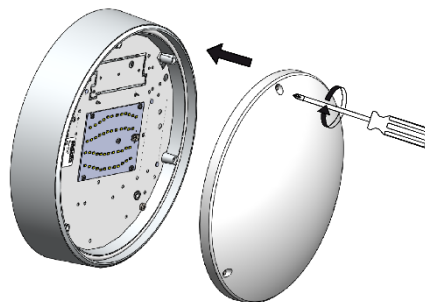

Refermer l'ensemble diffuseur ou diffuseur + grille.  
Serrer les 2 ou 3 vis de fixation imperdables à l'aide d'un tournevis adapté et de l'insert anti-vandale **98000003**.

## Entretien

L'entretien du luminaire se limite à un nettoyage du diffuseur pour une bonne luminosité, nettoyer le diffuseur (luminaire fermé) avec un chiffon humide ou à l'eau savonneuse.

 **NE PAS UTILISER DE DETERGENT**

## Maintenance

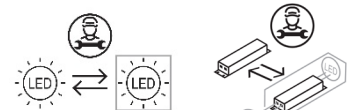

 La source lumineuse et l'appareillage contenus dans ce luminaire ne doivent être remplacés que par le fabricant, son agent de service ou une personne de qualification équivalente.

## Recyclabilité



**La gamme RONDO / RONDINO est une gamme de luminaire éco-conçue :**

- Toutes les pièces plastiques ou métalliques peuvent être démontées et recyclées dans une filière adaptée.
- Tous les composants électroniques tels que le circuit LED, l'alimentation, etc ... peuvent être démontés et recyclés dans une filière adaptée.

Z.I des Ajeux - 72400 La Ferté-Bernard - France  
Tél. : +33 (0)2 43 60 40 00 / Fax : +33 (0)2 43 60 40 09

 www.securlite.com

## Product, technical characteristics and features

### RONDO :

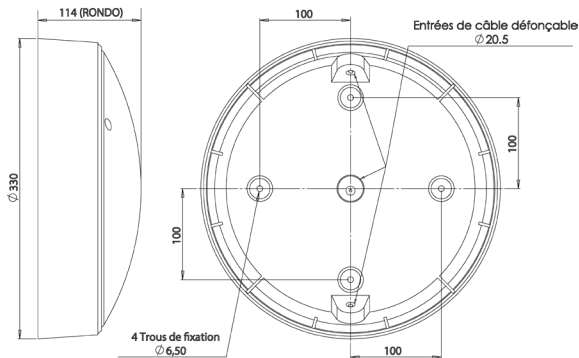

#### Standard installation kit:

Cable grommet **x1**  
Rubber washer **x4**  
Metallic washer **x4**

#### General characteristics:

Nominal voltage: **220 - 240V AC – 50 / 60 Hz**  
Input voltage range: **198V – 264V AC**  
Protection class: **I**  
Protection Rating : **IP66 (RONDO / RONDINO) / IP65 (With grid)**  
Mechanical impact resistance rating:  
**IK11++ / 120j (RONDO / RONDINO)**  
**IK11+ / 80j (With grid)**

### RONDINO :

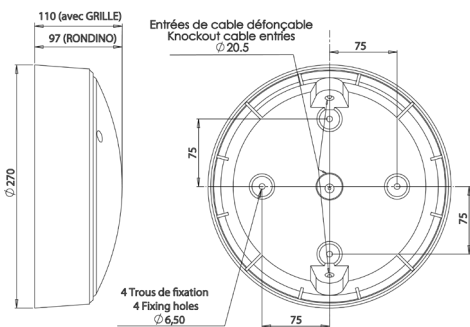

**Light source:** LED - this product contains a light source of energy efficiency class C.

**Power(s):** as per label product.

**Reference(s):** as per label product.

- Standard reference: **25xxxx00** no detection (see this instruction).
- Options regarding the end of product's reference (see specific instructions).

**Other reference(s) with option(s):**

- See specific instructions.

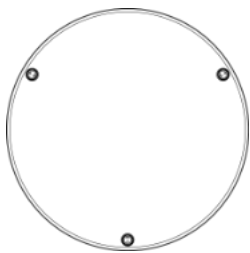

RONDO

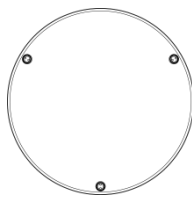

RONDINO

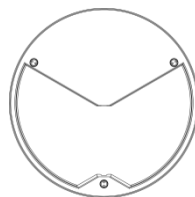

AKI

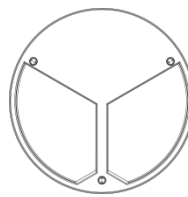

AKITA

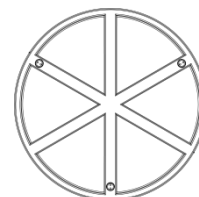

RUEDA

## Conditions d'utilisation

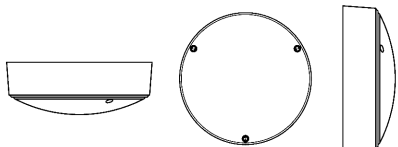
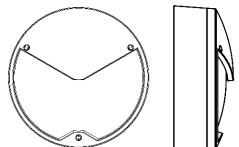
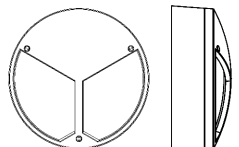
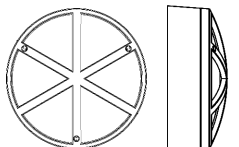
 <p>RONDO / RONDINO</p>	 <p>AKI</p>	 <p>AKITA</p>	 <p>RUEDA</p>
OK	OK	OK	OK

## Mounting / Installation



Warning, versions employing LEDs are at risk from ESD (electrostatic discharges).



Fitting & installation must be carried out by a professional installer in accordance with current installation standards.



Isolate the power before fitting and connecting up.

### Opening the luminaire:

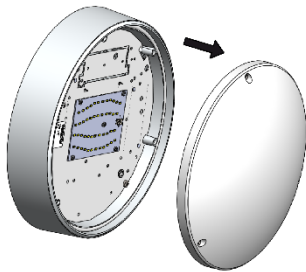

Remove diffuser or diffuser and grill

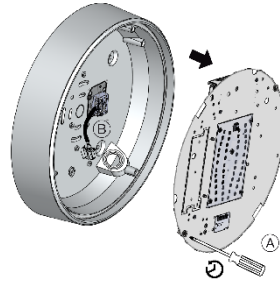

A – Unscrew the gear tray  
B – Disconnect the gear tray

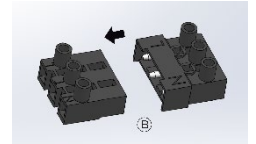

### Preparing the cable entry grommet:

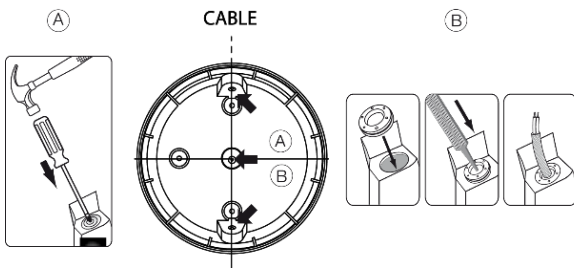

In order to ensure the luminaire is sealed, it is vital to use the cable grommets.

Use 1.5 mm<sup>2</sup> U1000R2V type cable (recommended to maintain sealing).

Use a pointed object to pierce the centre of a cable grommet. Do not use a blade, which might weaken the grommet and impair sealing.

Fit the grommet into the cable entry and feed the supply cable through it.

### Fixing :

Surface version :

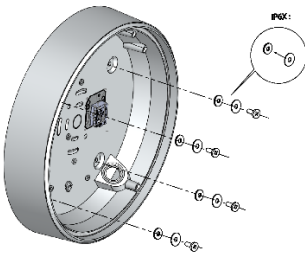

For mounting the luminaire, use 5 mm diameter flat-headed screws with fixing plugs suitable for the type of wall, in order to achieve optimum rip-out resistance. The screws and plugs are not supplied with the luminaire.

Use the rubber and metallic washer in order to maintain the sealing of the product.



Warning, versions employing LEDs are at risk from ESD (electrostatic discharges).

Flush mounted version :

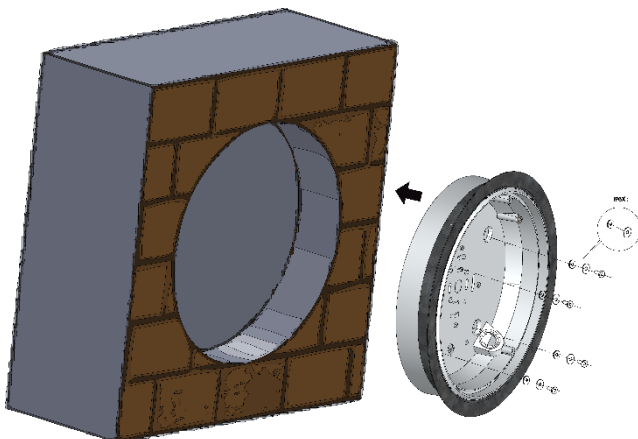

Z.I des Ajeux - 72400 La Ferté-Bernard - France  
Tél. : +33 (0)2 43 60 40 00 / Fax : +33 (0)2 43 60 40 09

 www.securlite.com

## Mounting / Installation

### Electrical connection (Standard reference 25xxx00):

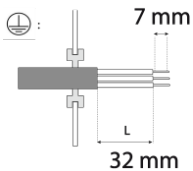

The cable must be prepared as per the diagrams.  
The conductors must be stripped for a length of 7 mm.  
Respect the polarity.

- For other cases, refer to the specific instructions for connection and splitting off.

### Closing the luminaire :

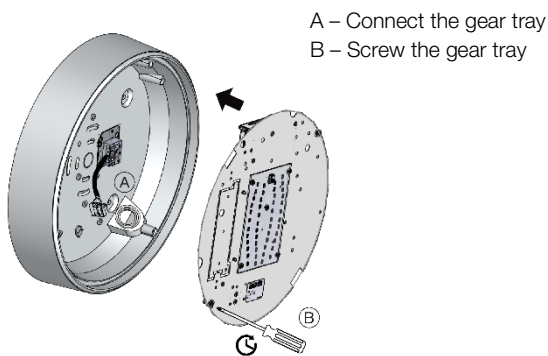

- A – Connect the gear tray
- B – Screw the gear tray

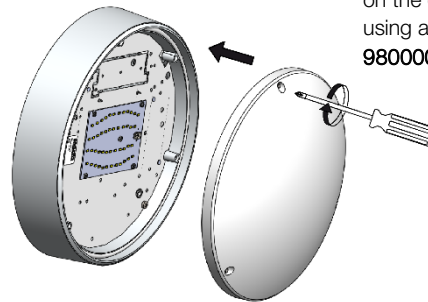

Tighten the 3 diffuser fixing screws on the diffuser or diffuser and grid, using a suitable screwdriver and the **98000003** vandal-resistant bit.

## Cleaning

Cleaning of the luminaire is limited to cleaning the diffuser for proper light output. Clean the diffuser (with the luminaire closed) using a damp cloth or with soapy water.



**DO NOT USE DETERGENT**

## Maintenance

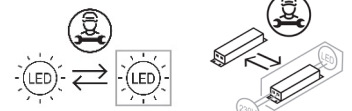

The light source and the control gear contained in this luminaire must only be replaced by the manufacturer or his service agent or a similar qualified person.

## Recyclability



### *The RONDO / RONDINO is an eco-designed luminaire:*

- All the plastic or metal components can be dismantled and recycled via appropriate facilities.
- All the electronic components such as the LED circuit, power supply, etc. can be dismantled and recycled via appropriate facilities.