

Produit, caractéristiques techniques et fonctionnalités

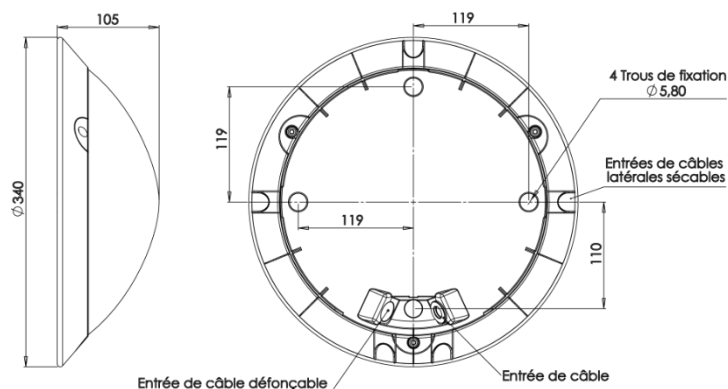

Kit d'installation standard :

Gaines isolation bornier secteur **x2**
Passe fils **x1**
Bouchons de protection **x4**
Cache vis **x3**
Visserie **x3**
Plug (suivant référence) **x1**

Caractéristiques générales :

Tension nominale : **220 - 240V AC - 50 Hz**
Plage de tension d'entrée : **198V - 264V AC**
Classe de protection : **II**
Indice de protection : **IP 65**
Indice de résistance aux chocs mécaniques : **IK10 / 20J**

Source lumineuse :

Ce produit contient une source lumineuse de classe d'efficacité énergétique C.

Puissance(s) : Se reporter à l'étiquette produit.







Référence(s) : Se reporter à l'étiquette produit.

- Réf. Générique : 105xxx**00** sans détection (se reporter à cette notice).
- Réf. avec terminaison optionnelle (se reporter à la notice complémentaire).

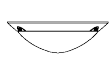
Autre(s) référence(s) avec option(s) :

- Se reporter aux notices complémentaires.

Conditions d'utilisation

						
LED	OK	OK	OK	OK	X	X

Montage / Installation



Attention, risque de chocs ESD sur les LEDs.



Le montage et l'installation doit être fait par un installateur professionnel en respectant les normes d'installation en vigueur.



Couper l'alimentation avant la pose et le branchement.

Ouverture du luminaire et préparation ensemble diffuseur + cache vis :

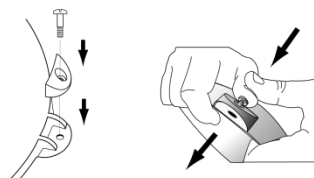

Déposer le diffuseur.

Positionner les 3 caches vis et clipser les vis sur le diffuseur.

Montage / Installation

Préparation passage et entrée de câble :

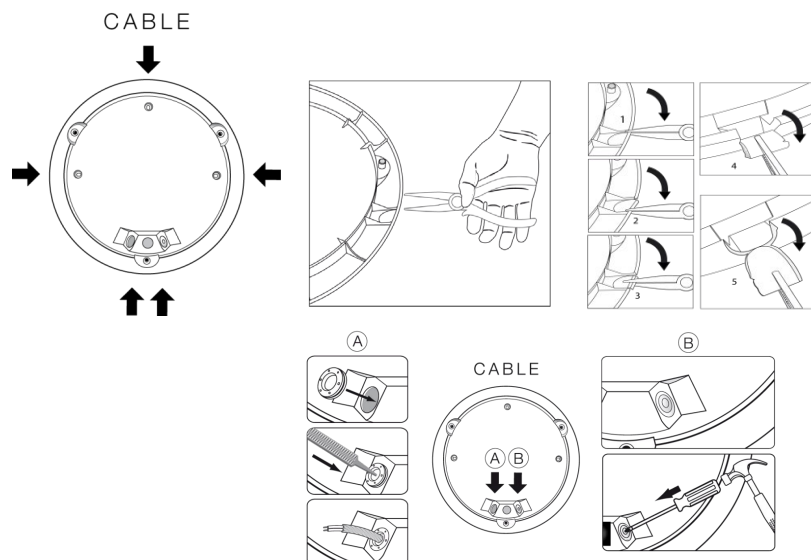

Pour une arrivée de câble latérale, utiliser les amorces de découpe présentes sur la base du luminaire. Afin de garantir l'étanchéité du luminaire l'utilisation des passes-fils est impérative. Utiliser un câble de type U1000R2V 1.5mm² (préconisé pour le respect de l'étanchéité).

Percer un passe fils en son centre à l'aide d'une pointe. Ne pas utiliser de lame qui pourrait fragiliser le passe fils et nuire à l'étanchéité. Monter le passe fils dans l'entrée de câble et introduire le câble d'alimentation au travers de celui-ci.

Fixation :

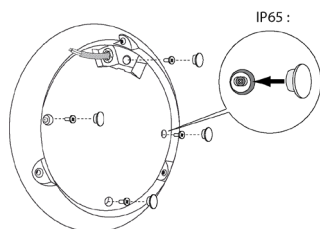

Pour la fixation du luminaire, utiliser des vis de diamètre 5mm à tête plate et des chevilles adaptées au type de paroi pour avoir une résistance optimale à l'arrachement. Les vis et chevilles ne sont pas fournies avec le luminaire. Positionner les 4 bouchons afin de respecter l'étanchéité du produit.

Raccordement électrique (Réf. générique 10xxxx00) :

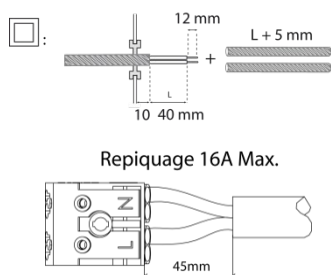

Le câble devra être dénudé selon schémas. Les fils devront être dénudés sur une longueur de 12mm. Les gaines de protection fournies dans le kit devront être enfilées sur les fils pour le respect de la classe II. Respecter la polarité.

➤ Pour autres cas, se reporter aux notices particulières pour raccordement et repiquage.

Modification du courant de pilotage suivant flux souhaité (cf FT0346 – svt référence et code option) :

 (à réaliser hors tension)

Version **350mA** pour code option 10xxxx00 / 10xxxx11 / 10xxxx16 :

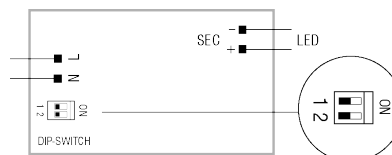

Switch 1 OFF
Switch 2 OFF

Version **400mA** pour code option 10xxxx00 / 10xxxx11 / 10xxxx16 :

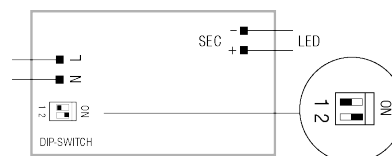

Switch 1 OFF
Switch 2 ON

Montage / Installation

Modification du courant de pilotage suivant flux souhaité (cf FT0346 – svt référence et code option) :

 (à réaliser hors tension)

Version **350mA** pour code option 10xxxx**13** / 10xxxx**03** / 10xxxx**17** / 10xxxx**07** :

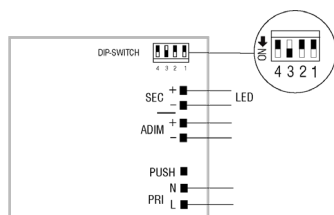

Switch 1, 2, 4 OFF
Switch 3 ON

Version **400mA** pour code option 10xxxx**13** / 10xxxx**03** / 10xxxx**17** / 10xxxx**07** :

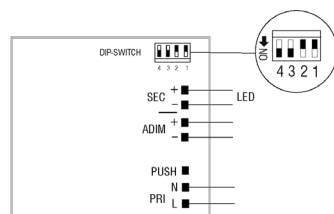

Switch 1, 2 OFF
Switch 3, 4 ON

Fermeture du luminaire :

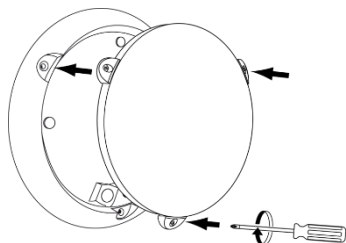

Refermer l'ensemble diffuseur caches vis.
Serrer les 3 vis de fixation du diffuseur à l'aide d'un tournevis adapté et de l'insert anti-vandale **98000003**.

Entretien

L'entretien du luminaire se limite à un nettoyage du diffuseur pour une bonne luminosité, nettoyer le diffuseur (luminaire fermé) avec un chiffon humide ou à l'eau savonneuse.

 **NE PAS UTILISER DE DETERGENT**

Maintenance

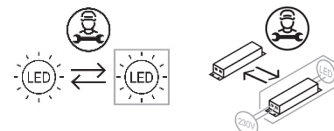

 La source lumineuse et l'appareillage contenus dans ce luminaire ne doivent être remplacés que par le fabricant, son agent de service ou une personne de qualification équivalente.

Recyclabilité



Le VOILA DURABLE est un luminaire éco-conçu:

- Toutes les pièces plastiques ou métalliques peuvent être démontées et recyclées dans une filière adaptée.
- Tous les composants électroniques tels que le circuit LED, l'alimentation, etc ... peuvent être démontés et recyclés dans une filière adaptée.

Product, technical characteristics and features

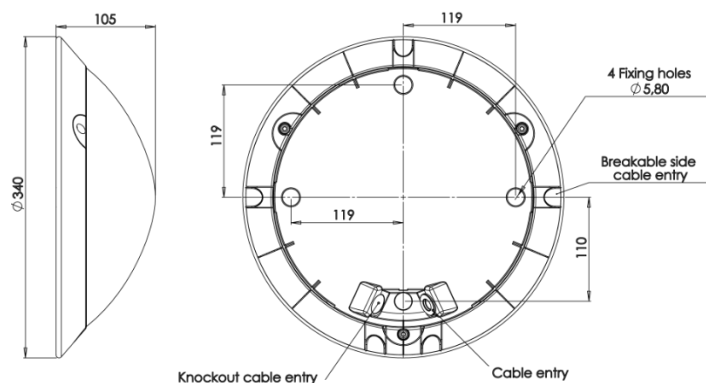

Standard installation kit:

- Mains terminal block insulating sleeves **x2**
- Cable grommet **x1**
- Protective blanking plugs **x4**
- Screw covers **x3**
- Fixing screws **x3**
- Plug (depending on reference) **x1**

General characteristics:

- Nominal voltage: **220–240 V AC / 50 Hz**
- Input voltage range: **198V – 264V AC**
- Protection class: **II**
- Protection rating: **IP 65**
- Mechanical impact resistance rating: **IK10 / 20 J**

Light source:

This product contains a light source of energy efficiency class C.

Power(s): as per label product.







Reference(s): as per label product.

- Standard reference: 105xxx**00** no detection (see this instruction).
- Options regarding the end of product's reference (see specific instructions).

Other reference(s) with option(s):

- See specific instructions.

Conditions of use

						
LED	OK	OK	OK	OK	X	X

Mounting / Installation



Warning, versions employing LEDs are at risk from ESD (electrostatic discharges).



Fitting & installation must be carried out by a professional installer in accordance with current installation standards.



Isolate the power before fitting and connecting up.

Opening the luminaire and preparing the diffuser + screw cover assembly:

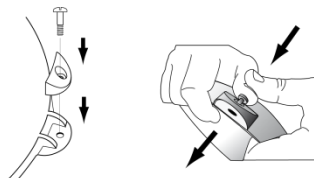

Remove the diffuser

Fit the 3 screws cover and clip the screws onto the diffuser.

Mounting / Installation

Preparing the cable entry grommet:

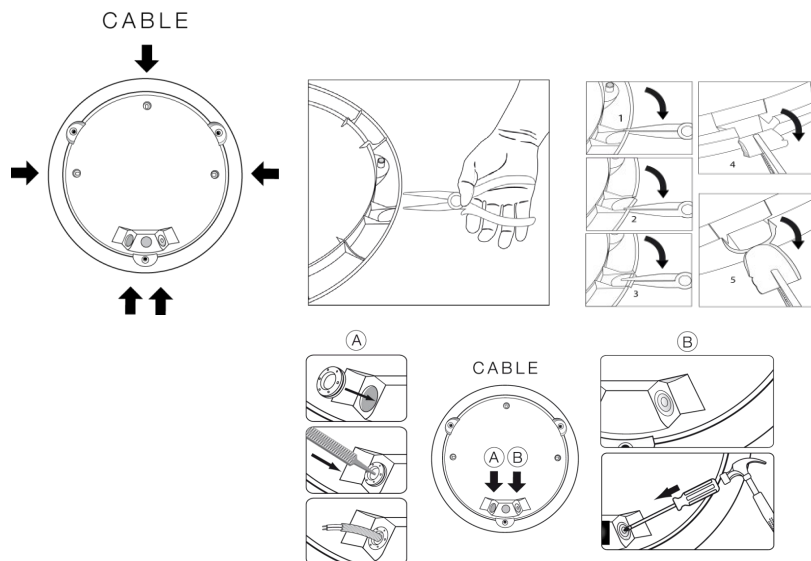

For side cable entry, use the knockouts provided in the luminaire base. In order to ensure the luminaire is sealed, it is vital to use the cable grommets. Use 1.5 mm² U1000R2V type cable (recommended to maintain sealing). Use a pointed object to pierce the centre of a cable grommet. Do not use a blade, which might weaken the grommet and impair sealing. Fit the grommet into the cable entry and feed the supply cable through it.

Fixing:

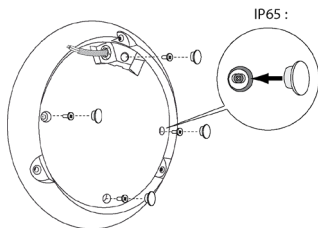

For mounting the luminaire, use 5 mm diameter flat-headed screws with fixing plugs suitable for the type of wall, in order to achieve optimum rip-out resistance. The screws and plugs are not supplied with the luminaire. Fit the 4 blanking plugs in order to maintain the sealing of the product.

Electrical connection (Standard reference 10xxxx00):

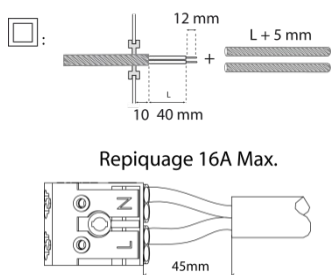

The cable must be prepared as per the diagrams. The conductors must be stripped for a length of 12 mm. The protective sleeves supplied with the kit must be threaded onto the wires, to comply with the Class II requirements. Respect the polarity.

➤ For other cases, refer to the specific instructions for connection and splitting off.

Modification of the control current according to the desired flow (see FT0346 – depending on reference and option code) :

 (to be done off-line)

350mA version for option 10xxxx00 / 10xxxx11 / 10xxxx16 :

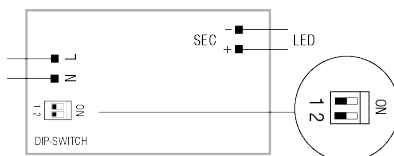

Switch 1 - OFF
Switch 2 - OFF

400mA version for option 10xxxx00 / 10xxxx11 / 10xxxx16 :

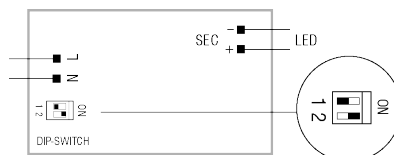

Switch 1 - OFF
Switch 2 - ON

Mounting / Installation

Modification of the control current according to the desired flow (see FT0346 – depending on reference and option code) :

 (to be done off-line)

350mA version for option 10xxxx**13** / 10xxxx**03** / 10xxxx**17** / 10xxxx**07** :

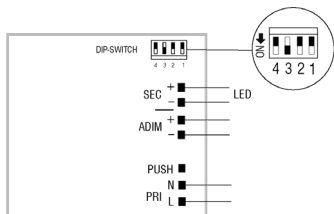

Switch 1, 2, 4 OFF
Switch 3 ON

400mA version for option 10xxxx**13** / 10xxxx**03** / 10xxxx**17** / 10xxxx**07** :

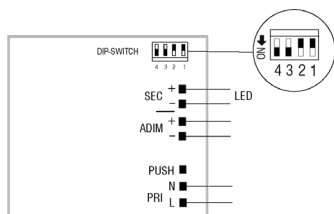

Switch 1, 2 OFF
Switch 3, 4 ON

Closing the luminaire:

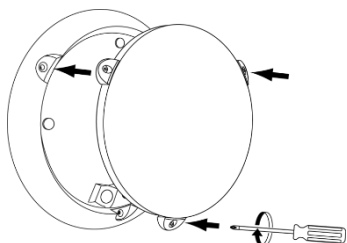

Tighten the 3 diffuser fixing screws + the screw covers on the diffuser using a suitable screwdriver and the **98000003** vandal-resistant bit.

Cleaning

Cleaning of the luminaire is limited to cleaning the diffuser for proper light output. Clean the diffuser (with the luminaire closed) using a damp cloth or with soapy water.

 **DO NOT USE DETERGENT**

Maintenance

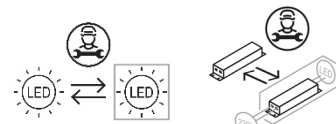

 The light source and the control gear contained in this luminaire must only be replaced by the manufacturer or his service agent or a similar qualified person.

Recyclability



The VOILA DURABLE is an eco-designed luminaire:

- All the plastic or metal components can be dismantled and recycled via appropriate facilities.
- All the electronic components such as the LED circuit, power supply, etc. can be dismantled and recycled via appropriate facilities.